



- 额定电流最高达 30A
Rated currents up to 30A
- 通用型滤波性能，高性价比
General purpose filtering performance compared to cost making
- 可选医疗型（M 型）
Optional medical versions (M type)
- 不同的出线连接方式
Different output connections
- 安规认证：
Approval: 

特点 Features

- 通用、紧凑、嵌入式/螺母/接线
General purpose, compact single phase filter with Faston/nut/wire connections
- 通用、小巧、方便安装、性价比高
General purpose, compact, easy for installation and use, cost saving to performance

应用 Application

- 用于电子设备和电子测量仪器
Available for electronic equipments and measuring instruments
- 白色家电、单相工业设备、电源供应和控制系统
White goods, single phase industrial equipments, power supply systems and controls
- 用于单相电源，开关电源，PLC 控制器
Single-phase power supplies, switch-mode power supplies, PLC controller
- 医疗设备及医疗特别应用（低泄漏电流）
Medical equipment and medical typical applications (Low current leakage)

技术参数 Technical Data

额定电压 Rated Voltage	125/250VAC
工作频率 Operation Frequency	50/60Hz
额定电流 Rated Current	1-30A
耐压测试 Hi-pot Test	1450VDC 2sec (线对线 Line to Line) 2250VDC 2sec (线对地 Line to Ground)
气候类别 Climate Category	25/85/21 (-25°C to +85°C)
设计参考标准 Design corresponding to	UL 1283, CSA 22.2 No. 8 1986, IEC/EN 60939

电路原理图 Electrical Schematic

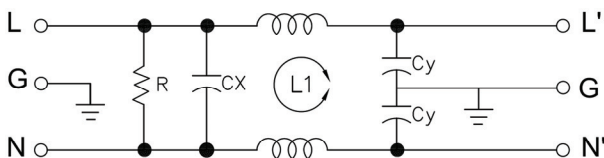

Fig 1

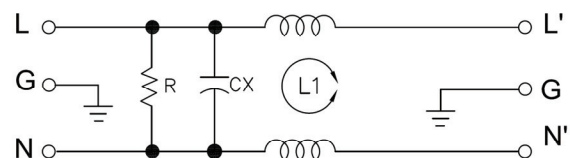

Fig 2

选型表 Type Selection Table

型号 Model	额定电流(A) Rated Current	泄漏电流(≤mA) Leakage Current	电路图 Circuit Diagram	外形尺寸 Dim. Fig.	出线端子方式 Output Connection		
							
DF200-1A-01	1	0.5	Fig 1	B2	B2-L	-	
DF200-1A-02	1	0.5	Fig 1	B	B-L	-	
DF200-3A-01	3	0.5	Fig 1	B2	B2-L	-	
DF200-3A-02	3	0.5	Fig 1	B	B-L	-	
DF200-6A-01	6	0.5	Fig 1	B2	B2-L	-	
DF200-6A-02	6	0.5	Fig 1	B	B-L	-	
DF200-10A-01	10	0.5	Fig 1	B2	B2-L	-	
DF200-10A-02	10	0.5	Fig 1	B	B-L	-	
DF200-15A-01	15	0.5	Fig 1	D	-	D-S	
DF200-20A-01	20	0.5	Fig 1	D	-	D-S	
DF200-25A-01	25	0.5	Fig 1	-	-	E-S	
DF200-30A-01	30	0.5	Fig 1	-	-	E2-S	
DF200-1A-01M	1	0.01	Fig 2	B2	B2-L	-	
DF200-1A-02M	1	0.01	Fig 2	B	B-L	-	
DF200-3A-01M	3	0.01	Fig 2	B2	B2-L	-	
DF200-3A-02M	3	0.01	Fig 2	B	B-L	-	
DF200-6A-01M	6	0.01	Fig 2	B2	B2-L	-	
DF200-6A-02M	6	0.01	Fig 2	B	B-L	-	
DF200-10A-01M	10	0.01	Fig 2	B2	B2-L	-	
DF200-10A-02M	10	0.01	Fig 2	B	B-L	-	
DF200-15A-01M	15	0.01	Fig 2	D	-	D-S	
DF200-20A-01M	20	0.01	Fig 2	D	-	D-S	
DF200-25A-01M	25	0.01	Fig 2	-	-	E-S	
DF200-30A-01M	30	0.01	Fig 2	-	-	E2-S	

Remark: Model name follow by: Blank represents Faston connection, L represents Wire connection, S represents Screw connection

标准型号为快速插片端子, 型号后加 L 为引线接线方式, 型号后加 S 为螺丝接线方式 “-” 表示无此出线方式

外形尺寸 Outline Dimensions(mm)

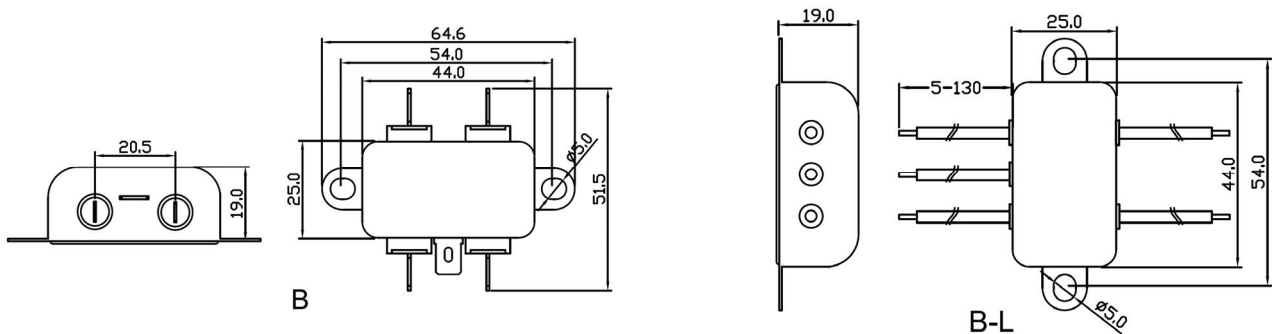

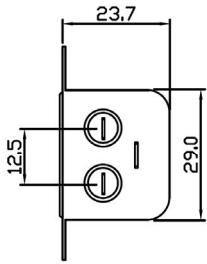

B2

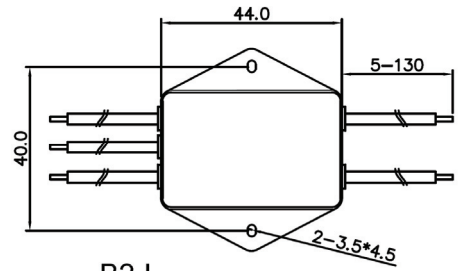
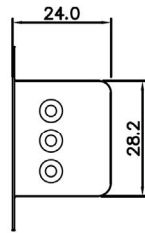
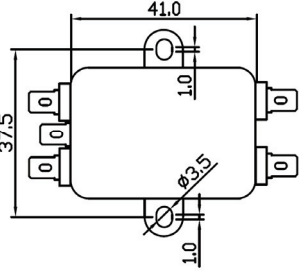

B2-L

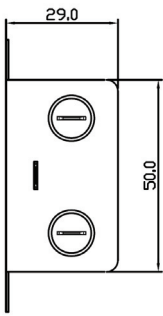

D

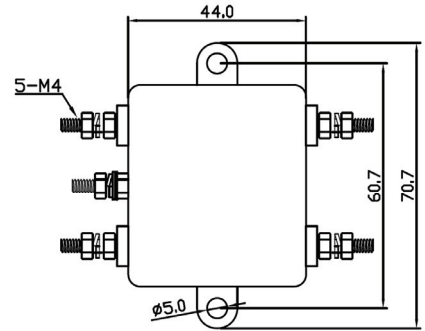
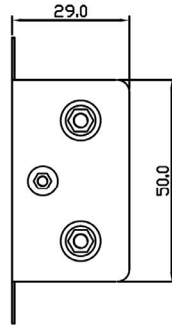
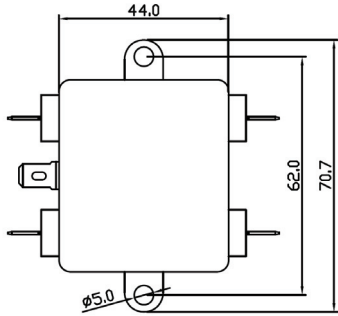

D-S

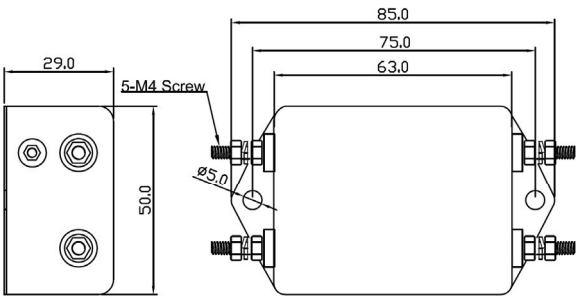

E-S

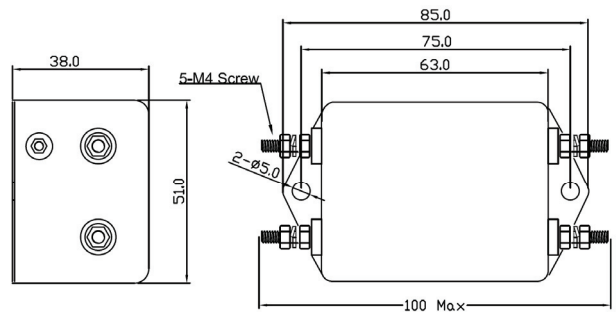

E2-S

插入损耗 Insertion Loss in dB

(50Ω/50Ω 环境下插入损耗 Insertion Loss in dB measured in a 50Ω/50Ω system, as IEC/CISPR No. 17)

A=Differential mode (差模) B=Common Mode(共模)

1 and 3A types

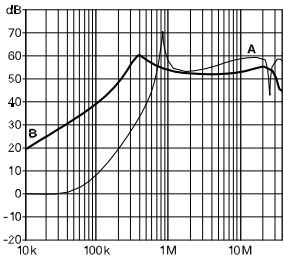

6 to 10A types

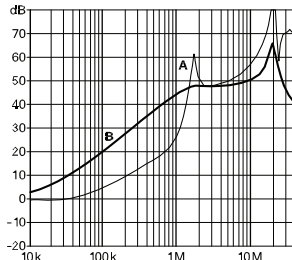

15 and 20A types

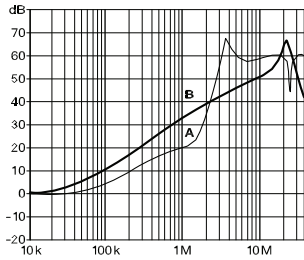

25 and 30A types

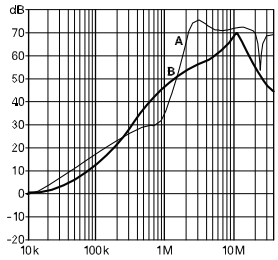

备注：以上规格为公司标准产品，可根据客户产品定制设计产品性能和尺寸外观。

Remark: Customized products are available according to special performance or dimensions requirements

更多产品请登陆官方网站: <http://www.dephir.com>

For more products please go to official website: <http://www.dephir.com>